

TROPEA S



**The silent revolution
in flush systems**



valsir[®]
QUALITY FOR PLUMBING



Tropea S, the revolution of silence

Technological innovation, attention to details and constant quality control, together with the desire to provide our clients with reliability and safety. These are the cornerstones that have always driven the design and production of Valsir cisterns over the years.

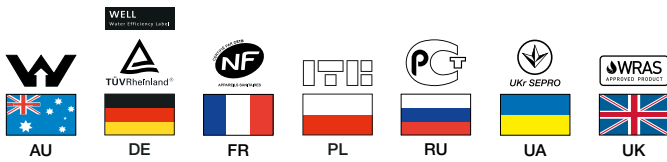

Tropea S represents an absolute novelty on the international scene, a state-of-the-art and innovative product: **the first cistern in the world designed to reduce the noise generated during use.**



Watch the Tropea S video
valsir.it/u/videtropneas

MADE IN ITALY



FROM THE HEART OF OUR KNOW-HOW IN ACOUSTIC SYSTEMS

The experience gained by Valsir in the Triplus®, Silere® and PP3 soundproof waste systems allowed us to reach levels of excellence also in our flush systems. To the numerous advantages of Tropea S we also added **silence**.

Tropea S is in fact the first cistern in the world made of a soundproofing plastic material.

Inside the Valsir Research and Development laboratories a special plastic compound was designed using a formula (exclusive to Valsir) with the aim of reducing the noise emissions from the flush cistern.

Laboratory tests show that **the perceived noise from Tropea S is 5 times lower** as compared to the most widely-used cisterns on the market.



5 TIMES BETTER

Silence without compromise also in internal components

The internal components of Tropea S have been certified in the prestigious **Fraunhofer Institute of Stuttgart**, in compliance with **ISO EN 3822 Class I**.

Tropea S is the only in-wall cistern on the market with a float valve and a stop valve certified at the top of the category in terms of reduced noise emissions.

Not only high mechanical performance but also **excellent acoustic performance**.





THE ADVANTAGES OF CHOOSING TROPEA S



The material of the container is designed to ensure **high absorption of acoustic vibrations**.



The cistern is supplied **100% pre-assembled** to improve installation speed and simplicity on the site.



The rotating water connection fitting **simplifies cistern installation**.



Patented by Valsir, the flush valve guarantees the **cleaning** of all **pan** types, including Rimless pans (provided that it is compliant with the standard in force).



The different plastic materials of the flush and float valve **avoid the formation of limescale**.



The internal components of Tropea S are certified according to **ISO EN 3822**, in **silence** class I both at 3 and 5 bar.



Float valve with air-water separation circuit able to guarantee low noise levels as well as to protect the potable water network from pollution, with absolute pressure up to 0.8 bar.



Extreme versatility of activation type: **mechanical, pneumatic, electronic, electronic and mechanical, or mechanical and pneumatic** at the same time.



All **rubber components comply with EN 681/WC**, a guarantee of their unmatched quality and **resistance to chemical agents**.



Flush regulation with Tropea S is extremely easy and can be set at 6/3, 4.5/3 or 4/2 litres fully in accordance to water saving philosophy and Green Building requirements.

The Fixsystem template make it easy

To enable a rapid and simple installation of the Fixsystem frames, **we have designed an installation template that is very practical and drastically reduces installation time**.

This accessory was designed to provide an installation support during the installation phases of the Tropea S and Winner S Fixsystem frames to the wall. In this way the job can be done by only one person guaranteeing the best result.



Watch the video
valsir.it/u/videodimafix



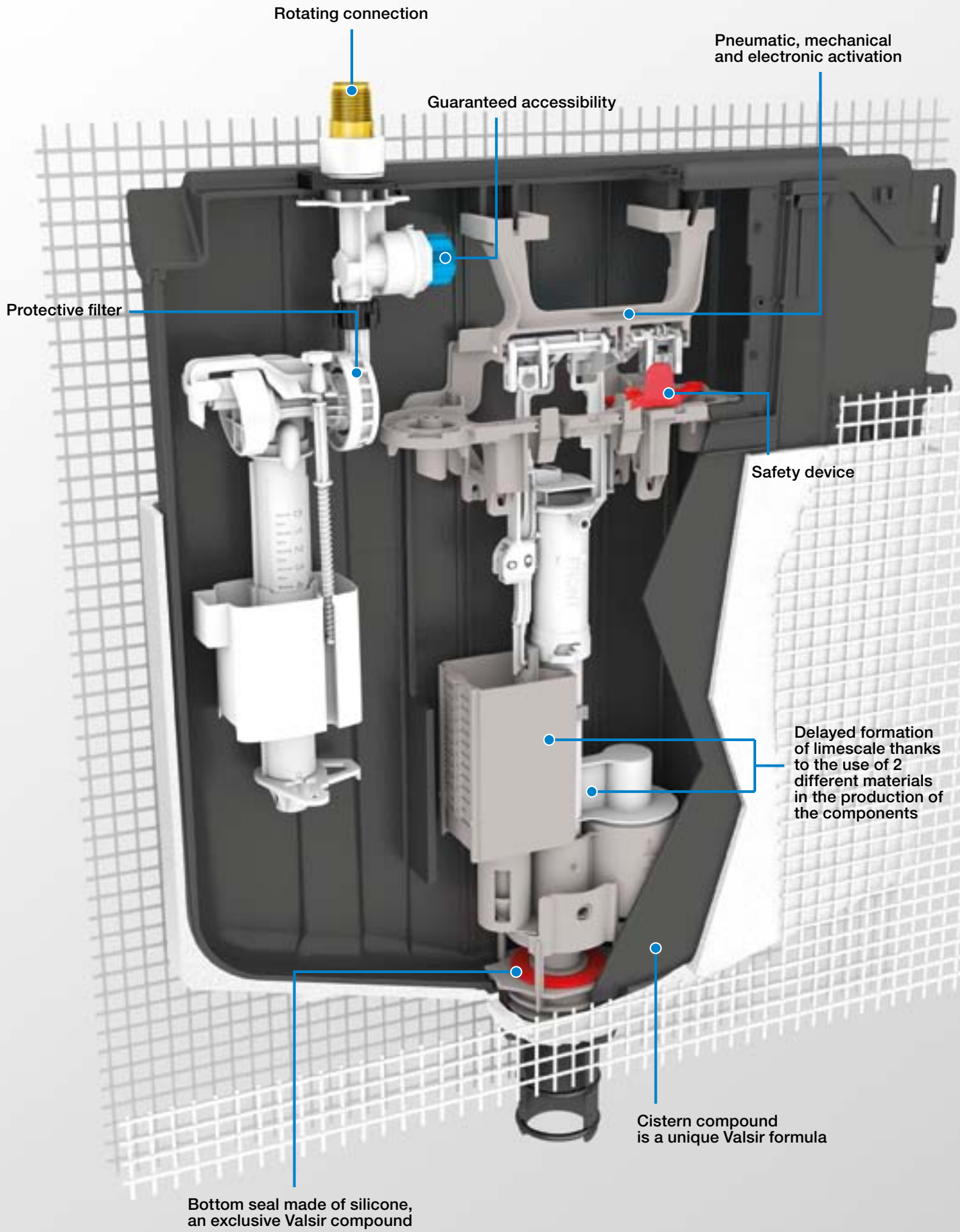

Rotating connection

Pneumatic, mechanical and electronic activation

Guaranteed accessibility

Protective filter

Safety device

Delayed formation of limescale thanks to the use of 2 different materials in the production of the components

Cistern compound is a unique Valsir formula

Bottom seal made of silicone, an exclusive Valsir compound

THE ALL-TIME SUPERLATIVE TECHNOLOGY

Inlet valve

It is made entirely of technopolymer and **pre-fitted** in the cisterns to **make installation easier and faster**; the system also incorporates an **accessible closing device** to always guarantee perfect performance.

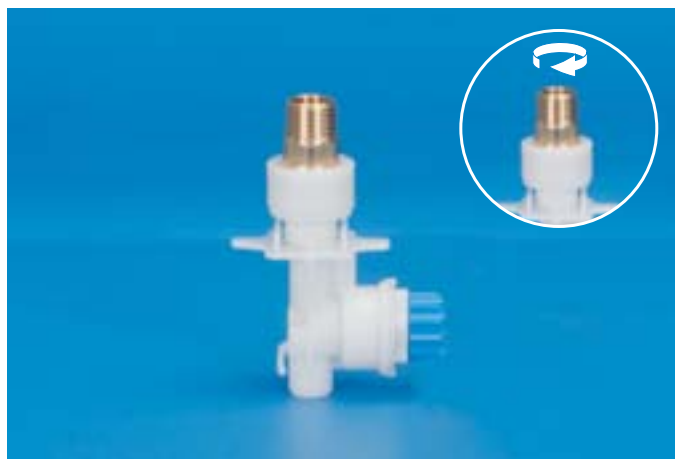

Compact float valve

Designed and produced to guarantee maximum reliability in all situations, it **resists water hammer as great as 30 bar**. The internal accessible filter and the absence of a hose allow an easy maintenance and guarantee an excellent level of silence. **It is certified in accordance with EN 14124.**

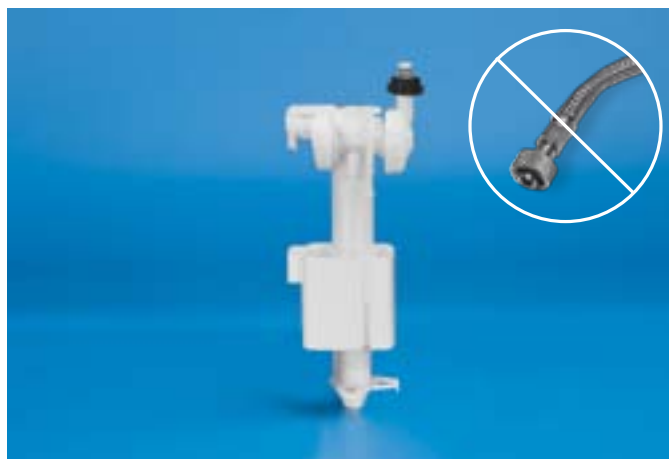

Outlet valve

The resistance to limescale of its components, the self-regulation to the WC pans present on the market, and the blends of the seals that resist to the corrosion effect over the years, **make it the most reliable valve on the market.**



Safety device

The device guarantees the **perfect position and protection of the internal components during handling of the cistern** until the push plate is installed.



TROPEA S INSTALLATION VERSATILITY

Regardless the installation type, Tropea S is the ideal solution. The wide range of frames, the available accessories and the technical solutions adopted

inside the cistern guarantee flexibility, speed and adaptability to all types of walls and installation requirements.

Tropea S in masonry walls

It is designed for **installation in walls of reduced thickness** made of brick or wood with floor standing WC pan. The flush pipe allows an adjustment of 20 mm upwards or downwards to correct any misjudgements of height once the floor has been completed.

All the materials necessary for installation are included in the packaging and it is **available with the Valsir Ariapur odour extractor system**.

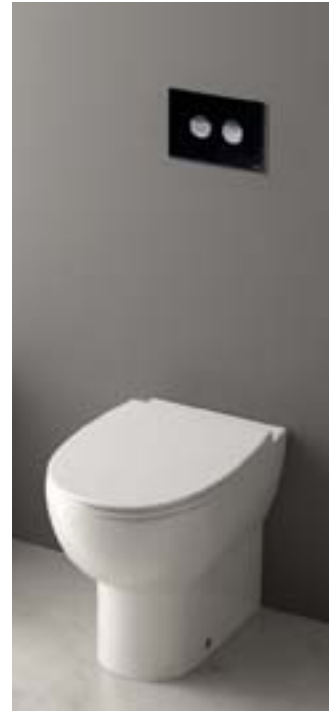

Tropea S Fixsystem

Suitable for the installation of **wall-hung pans** in masonry walls, the Fixsystem frame incorporates an **extended compact WC bend** to allow installation in 90 mm walls.

The frame and all the anchor points are made entirely of galvanized steel to guarantee maximum corrosion resistance.

Tropea S Fixsystem S86 is **available with the Valsir Ariapur odour extractor fan**.



Tropea S Block S90

It incorporates a painted steel frame that is ideal for **installations in light or mixed walls (plasterboard, wood) with wall-hung pans.**

The reduced depth (90 mm) and the compact WC bend allow installations in all wall types.

The painted surface gives the frame greater corrosion resistance over time.

Tropea S Block S90 is **available with the Valsir Ariapur odour extractor system.**



Free-standing Tropea S Block

Made of painted steel, it is designed for **installations in light or mixed walls (plasterboard, wall) with a wall-hung pan.** Thanks to the peculiar structure of the legs that are anchored to the floor, the frame does not require any other anchor points to the wall structure.

The painted surface gives the frame greater corrosion resistance over time.



WHAT'S NEW ON TROPEA S FLUSH CISTERNS: KEEP AN EYE ON THE LABEL

The Tropea S in-wall flush cisterns have been awarded **the Best WELL rating** for water saving: a useful help for plumbers, designers,

architects and all customers in choosing the right WC flush system.

Greater water efficiency, without altering the performance

Drinking water: a resource threatened with exhaustion. In Europe, due to climate change and irregular nature of outflows, in certain periods of the year the total amount of water available decreases and can not meet the daily needs of all people. An increase in the demand of drinking water produces a rise in expenditure for water treatment and transportation and an increase in the energy needed to heat water.

Regarding the ecological strategy ongoing in the plumbing and heating sector, EUnited Valves (the association that represents the main European valve producers) has developed a new European classification system: **WELL - Water Efficiency Labelling**. Thanks to the WELL rating, the efficiency in terms of energy saving of the WC flush systems are immediately assessed by **designers, architects, plumbers and end users**.

It is important to know that the pre-condition to obtain the WELL certification is **passing a strict approval process** - in accordance with **DIN EN 14055 and DIN 4109**.

The tests are performed in an accredited ISO 17025 laboratory only in the case of products with noise levels not exceeding 20 dB(A) with a pressure of 3 bars and noise levels not

exceeding 25 dB(A) and a pressure of 5 bar (Class I). The test laboratory is the TÜV LGA which, following the approval assignment, carries out annual audits and inspections on the product, therefore in compliance with WELL requirements.

How to read the WELL label of water saving and make the right choice

According to ISTAT, about **30% of the water consumption** used in an average family **goes away for flushing toilet** (ISTAT, 2005). You can save a lot by implementing virtuous behaviors without compromising the functionality of the wc system. If we consider that a four-member household discharges the flushing toilet at least 12 times per day, the consumption of drinking water can be reduced by 68% using a **4-litre double flush cistern**, using the minimum volume of water, as shown in the following table:

Example of potential water-saving

Water consumption for a 9-litre flush cistern:
 $12 \times 9 \text{ l} = 108 \text{ l/day}$

Water consumption for a 4-litre double flush cistern:

5 x 4 l = 20 l/day

7 x 2 l = 14 l/day

Water saving 74 l/day

For the purposes of the WELL classification and the assignment of related points, it is considered the unit of system composed by

the flush cistern and the push plate.

In this way, the single flush cisterns (without points for classification) can be equipped with a push plate and start/stop function (1 star) or double flushing (2 stars). With the latter, a saving rinsing is carried out that puts into circulation the exact amount of water needed for the cleaning activity.

Below is the table with the classification criteria:

Rating criterion	Performed by	Rating
Volume/flush volume	Flush volume (fixed or adjustable) 6.0 l	★
	Flush volume (fixed or adjustable) 5.0 l or 4.0 l	★★
Flush program	Undefined flush with minimum volumes	★
	Defined minimum volume flush	★★

Total: max. 4 stars

Tropea S: the 4 star “home” WC flush system

Water is an indispensable resource for existence and therefore needs proper management: this is one of the most important challenges of **sustainable development**. In recognition of this problem, Valsir is constantly committed to promoting careful and water-parsimonious use of water by producing efficient and environmentally friendly systems, which are respectful of the environment that is home to us.

Below is **the WELL - Water Efficiency Label** (the “home” category) assigned to the Tropea S in-wall flush cistern: a descriptive guidebook guides you in the reading of main features.

Look for the WELL label with Valsir and ask for more information. We will be happy to offer you the right advice.

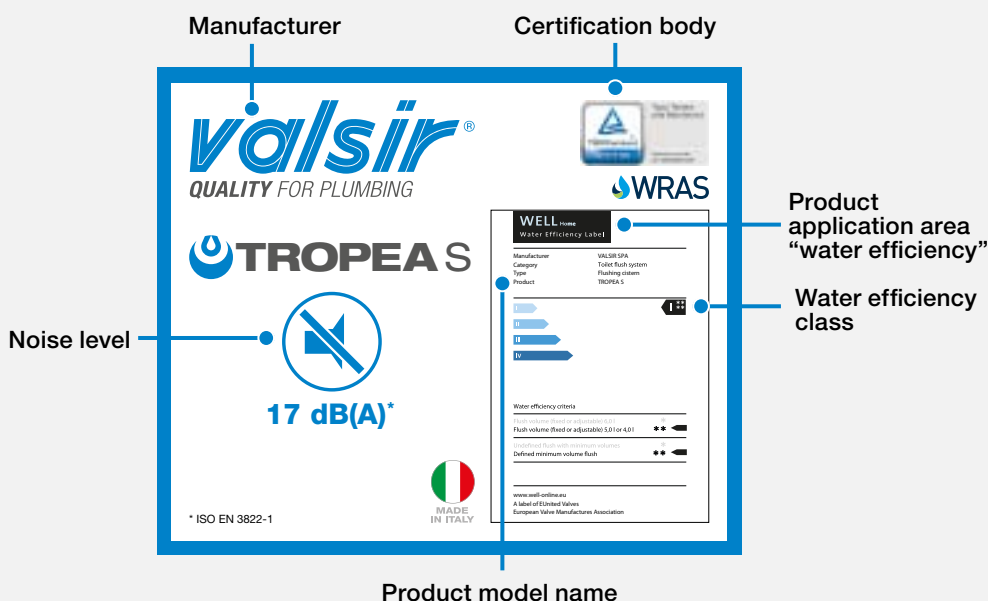

ARIAPUR, THE ODOUR AND VAPOUR EXTRACTOR FAN

Ariapur is an extractor fan that performs a dual extraction function, thus ensuring the perfect renewal of air inside the bathroom.

Ariapur **extracts air both through the wall or ceiling extraction grid and through the WC pan** as it is connected to the flush pipe.

Its capacity to eliminate odours before they spread to the room makes it the most effective and innovative extractor fan on the market.



Watch the Ariapur video
valsir.it/u/videoariapur

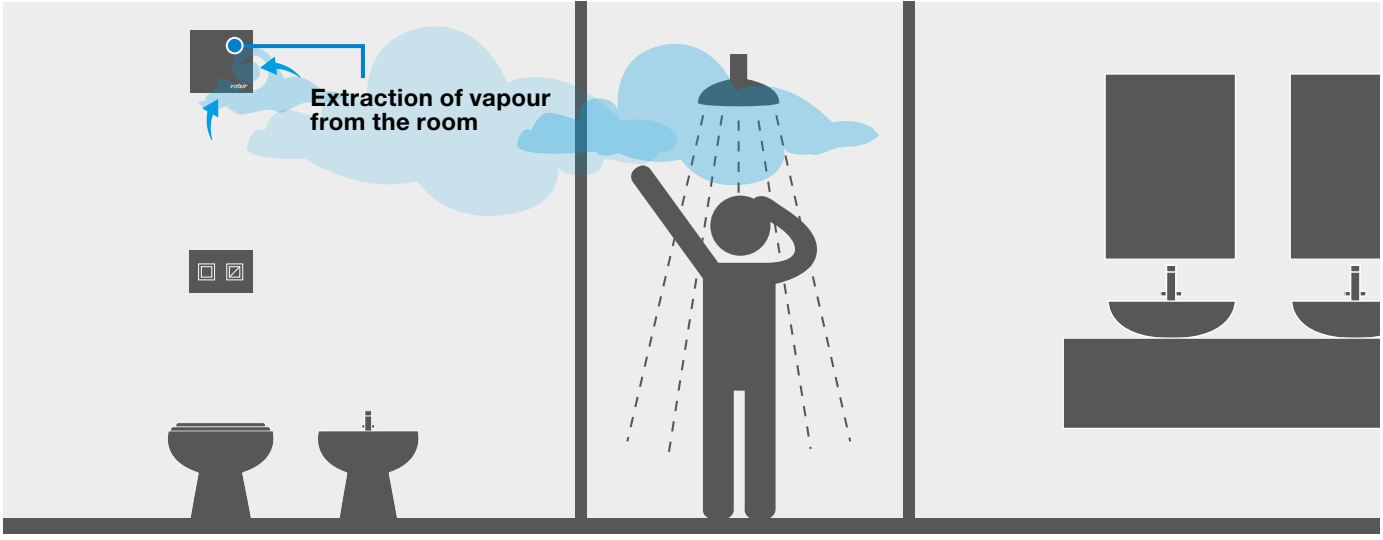
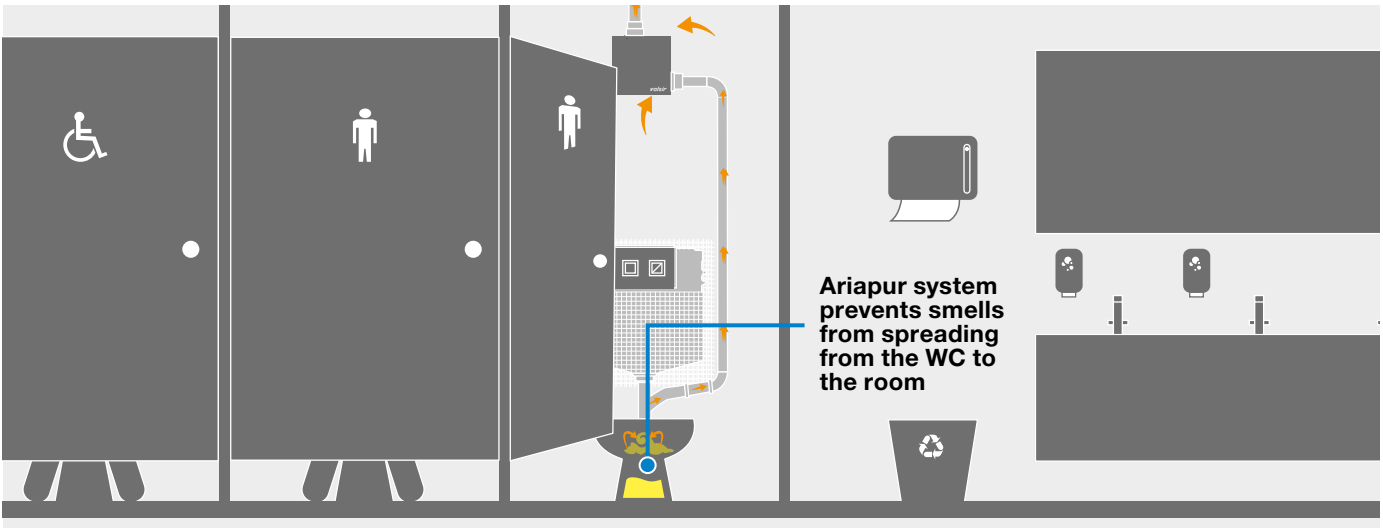
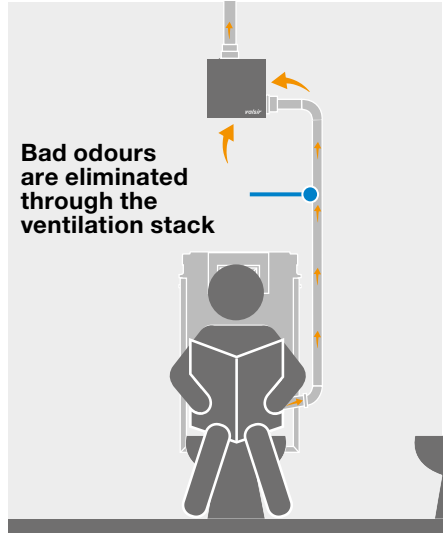
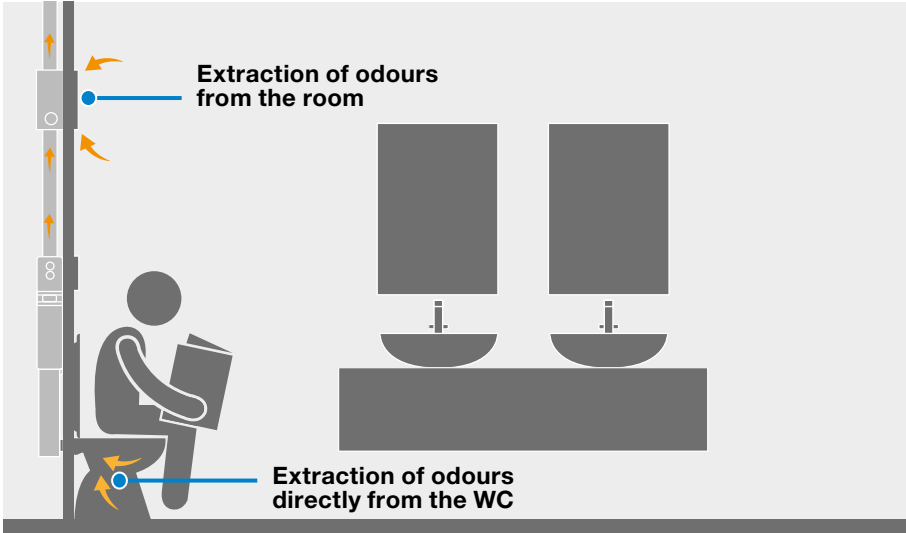

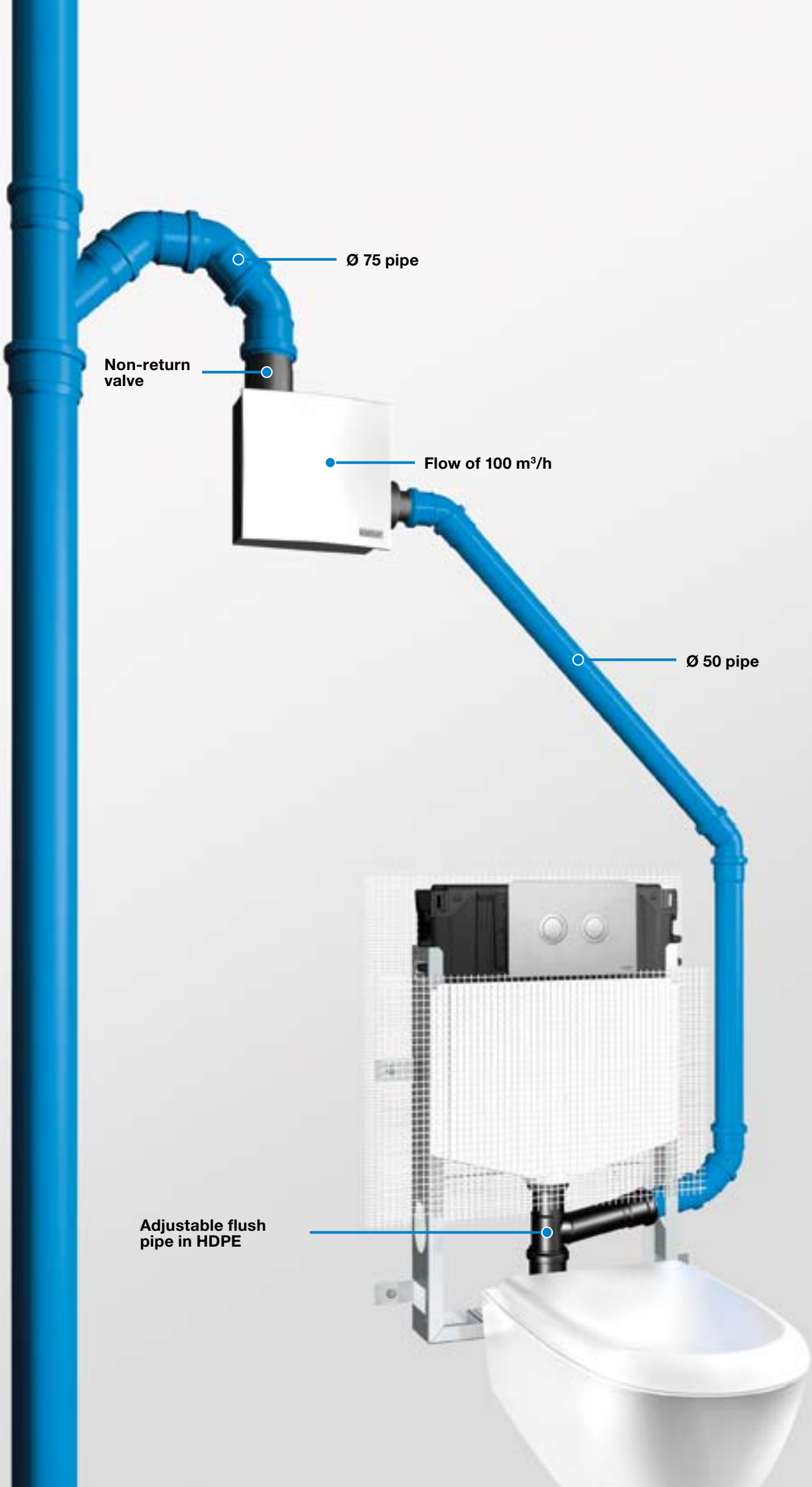

Ø 75 pipe

Non-return valve

Flow of 100 m³/h

Ø 50 pipe

Adjustable flush pipe in HDPE

THE GUARANTEE OF THE PERFECT AIR EXCHANGE

Non-return valve

The valve, positioned on the outlet side, **prevents the return of odours** generated inside the stack. Thanks to the non-return device, **Ariapur does not require its own stack** but can be connected directly to the ventilation stack of the waste system.



Connection flexibility

The adjustable flush pipe allows obstacles in the installation phase to be overcome. **The connection can be positioned to the right or left** and it is equipped with a push-fit socket joint.



Also for thin walls

By using the special frame, **Ariapur can be installed in walls of just 80 mm**. If installed without the frame, the minimum thickness is 100 mm. Ariapur can be painted and fits in discreetly in any bathroom.



Choice of activation

Ariapur can be electrically activated. Activation can be chosen from: traditional switches and presence detectors. It incorporates an internal **timer to guarantee the correct renewal of air** pre-set at 6 minutes.



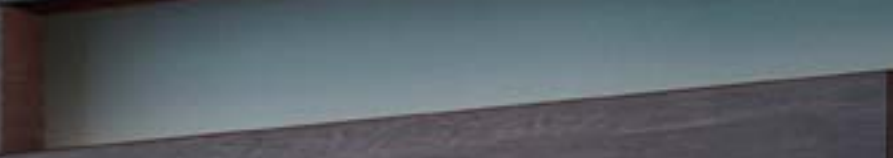

PUSH PLATES: FURNISH WITH STYLE

Today, the push plate is no longer just an element required to activate the flush cistern, but inside the bathroom it has acquired an important aesthetic value, thus truly becoming an object of design.

Tropea S offers a multitude of choices with new solutions that are combined with classical materials such as metal or plastic materials.

The latest trends range from stainless steel to the elegance and cleanliness of tempered glass; from new materials such as white acrylate, black acrylate and anodized aluminium, to the innovative installation methods, such as the wall-flush plate and the customization kit.

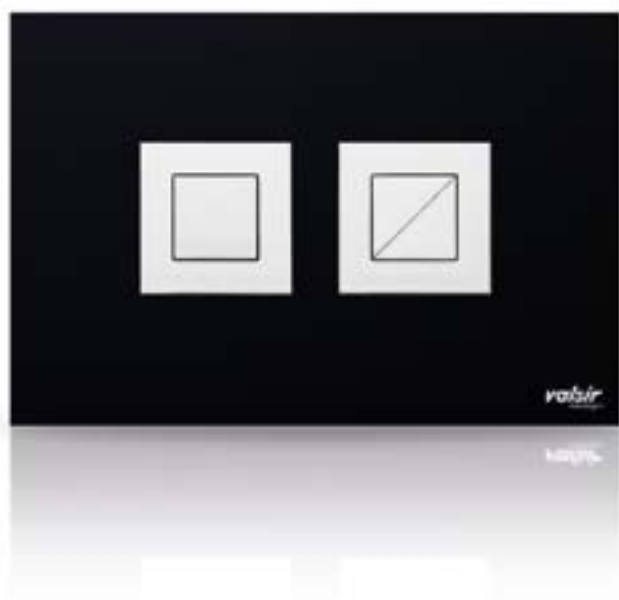



VALSIR DESIGN PLATES

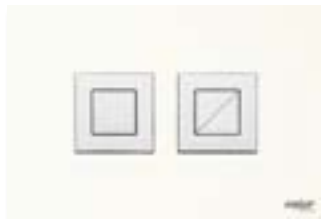
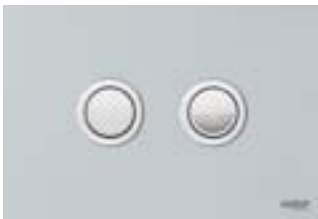
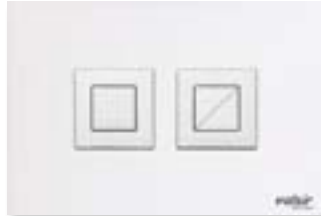

Over 35 models with 250 possible combinations, the push plates are created using innovative and elegant materials that allow all bathrooms to be customized with a touch of style.

The refined transparency of the Crystal line, the essential elegance of stainless steel, the creativity of the Fantasy line and the solidity of wood and stone of the Wood and Stone line using the new materials such as anodized aluminium and DuPont™ Corian® find space in a new environment: the bathroom.

All the Valsir Design plates incorporate buttons made with different finishes, characterised by soft actuation, silence and precision.

Customization kit

The customization kit allows you to create your own actuation plate using the same materials of the bathroom tiles.

The kit includes a template for cutting, a frame in stainless steel and round or square and polished or satin activation buttons.

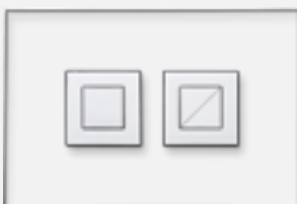

Customized plate kit, polished chrome



Customized plate kit, satin chrome



FEEL, THE WALL-FLUSH PLATE

Valsir has developed a system that allows the easy installation of the plate inside the wall. Installation is simple, the job is flawless and the result is perfect!

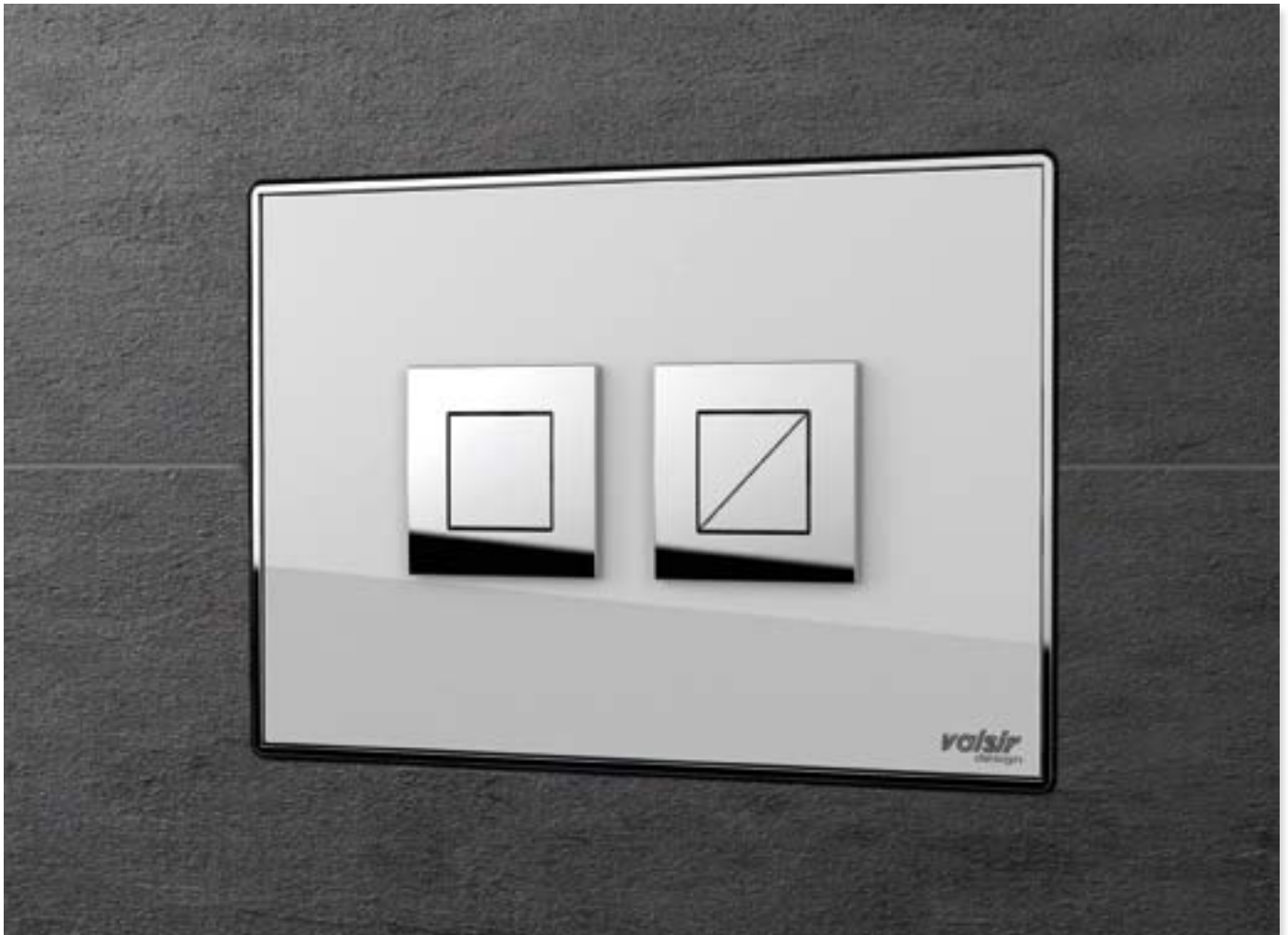

PLATES

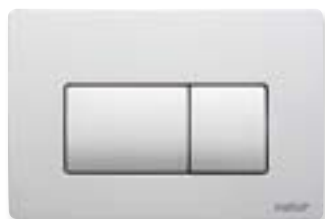

P1 - 215x145 mm
 Finishes: white - polished
 chrome satin chrome



P2 - 215x145 mm
 Finishes: white - polished
 chrome satin chrome

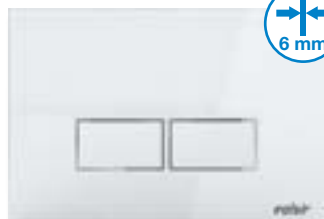

P3 - 215x145 mm
 Finishes: white - polished
 chrome satin chrome



P4 - 215x145 mm
 Finishes: white - polished
 chrome satin chrome



P5 - 215x145 mm
 Finishes: white - polished
 chrome satin chrome - white
 and gold chrome



P6 - 245x165 mm
 Finishes: zama polished chrome
 zama satin chrome



P7 - 215x145 mm
 Finishes: polished inox - satin
 inox

The P5 plate gets a new look

The P5 plate allows maximum customization creating unique combinations of buttons and masks with various finishes: white, polished chrome, satin chrome and gold chrome.

Customized finishes can also be requested.





INFRAROSSA AND REMOTE CONTROLS

The “Infrarossa” electronic push plates, made of robust chrome metals **are the ideal solution in public and commercial locations**, such as hospitals, airports, and shopping centres and in bathrooms for those with disabilities.

They also incorporate a vandal-proof system to guarantee maximum safety and inaccessibility.

By means of the plates in the Infrarossa range, the flushing system is activated automatically, ensuring hygiene and functionality in all situations.

The plates also provide an automatic flush every 24 hours. In this way, cleansing of the pan and total hygiene are guaranteed.



Dual - 245x165 mm
Finishes: polished chrome



Eye - 245x165 mm
Finishes: polished chrome



Remote - 245x165 mm
Finishes: polished chrome

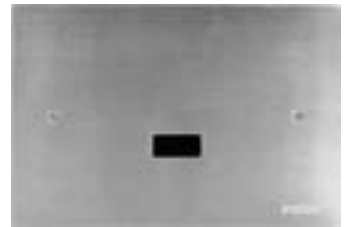

Inox - 215x145 mm
Finishes: satin inox

Pneumatic activation is achieved by means of wall buttons (R line) and floor buttons (FOOT) made of steel or plastic.

The R line allows single activations with a dual flush both level with the wall or with a protrusion. Ease and activation smoothness are always guaranteed, ensuring installation flexibility with distances between the button and the cistern of up to 2.5 m.



FOOT1 - 120x120 mm
Finishes: polished inox



FOOT2 - 110x160 mm
Finishes: polished inox



R1 - Ø 105 mm
Finishes: white - polished chrome - satin chrome



R7 - 175x100/155x85 mm
Finishes: polished chrome - satin chrome

EASY-TO-USE PLATES

The activation plates with facilitated activation further enhance the flexibility of the range of pneumatically operated buttons.

Designed for bathrooms for people with disabilities, pneumatic button controls were specifically created for an easy actuation: the required pressure is lower, the feeling is smoother and they are available in the protruding version as well.

For the partially sighted, buttons were created with chromatic differences between the full and partial flush. In this way the difference is more visible.

It is the only cistern on the market that can have double mechanical and pneumatic actuation at the same time.

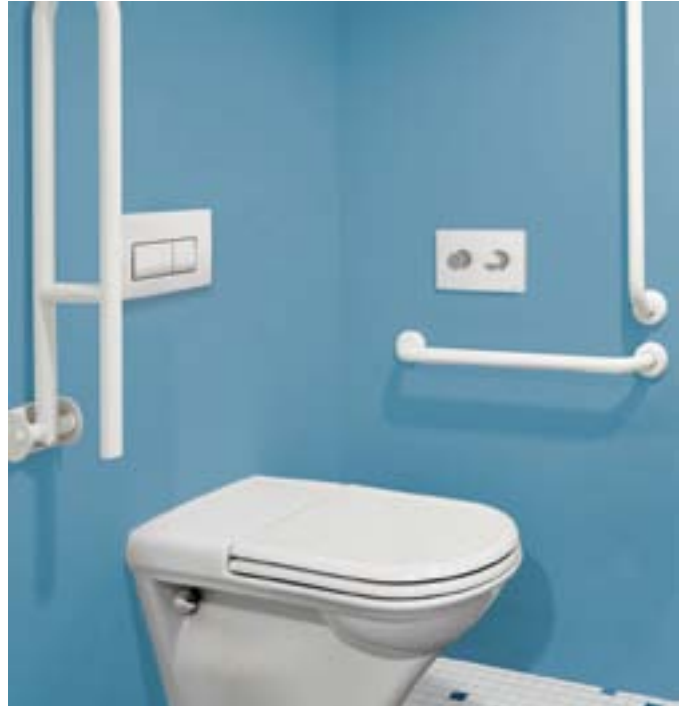

R3



R4



R5



R6



SECURITY, TAMPER RESISTANT PUSH BUTTON



The Valsir cistern control systems stand out for their ease of installation and regulation, always guaranteeing system accessibility. The Security button, created to meet the requirements of installations in thick walls, was designed according to a concept of total safety and inalterability, which makes it the ideal solution for vandal and tamper resistant applications.

- Installation in thick walls (max. 400 mm).
- Maintenance guaranteed thanks to total system accessibility.
- Easy to install and to adjust.
- The installation requires a hole of just 42 mm in diameter.
- Vandal resistant system.
- The ideal solution in clinics, stadiums and prisons.

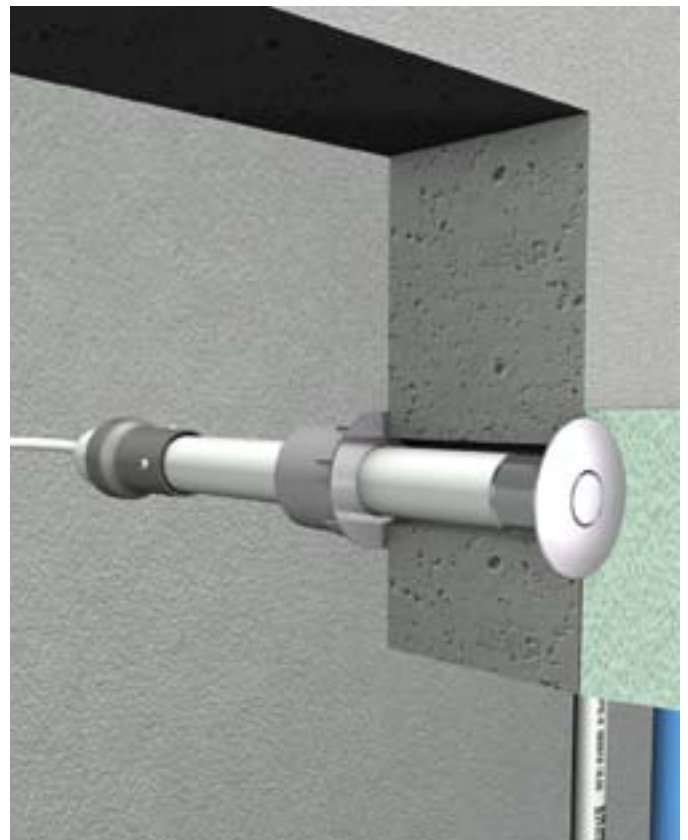



CUSTOMER SERVICE

Technical support

Valsir provides complete support during design and on site, thanks to a high-level technical department that consists of a team of engineers with international experience that are capable of providing solutions to all installation needs.



Valsir Academy

Valsir has an important training facility - **Valsir Academy** - dedicated to clients, distributors, plumbers and planners that provides perfectly equipped courses, theoretical and practical courses on the use and the design of plumbing and heating systems. Courses are provided both inside the training facility and on customers' premises.

SOFTWARE

Silvestro software

The design of floor and radiator heating systems, water supply as well as waste and drainage systems, is extremely easy and the issue of the project technical documents is rapid when using the Silvestro software program. Rapid, simple, unique, Silvestro has numerous strong points:

- rapid learning curve thanks to a simple and intuitive interface
- completely graphic background that facilitates input of the project details
- automatic drawing of the loops in the floor radiant systems
- automatic repositioning of the stack points on the plan view
- generation of calculation reports that are exportable in an .xls format
- import and export of files in .dwg format
- immediate update of software with a guided procedure
- creation of complete bill of materials from the project files

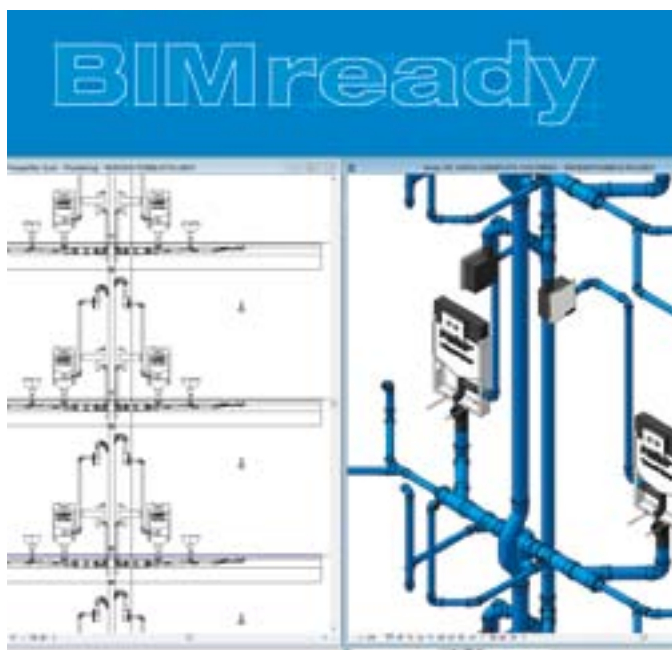

Valsir is BIM ready

Valsir has embraced the BIM philosophy, the modelling process that allows the improvement of planning, design, construction and the management of buildings, concurring with the transition of the industry toward the digital representation of buildings. "BIM oriented" planning offers extraordinary competitive advantages: greater efficiency and productivity, fewer errors, less downtime, lower costs, enhanced interoperability, maximum sharing of information, a more punctual and coherent supervision of the project. Valsir captures the essence of this system creating a series of Revit applications and models designed for simple and fast use.

QUALITY AND ENVIRONMENT

Quality

The ongoing commitment of Valsir to the creation of high quality products is demonstrated by over **190 product approvals** obtained around the world from the most strict certification bodies (figure updated on 01/05/2018), by the Quality Management System that is certified in compliance with **UNI EN ISO 9001:2008** and the Energy Management System that is certified in compliance with International Standard **UNI EN ISO 50001:2011**.

Valsir S.p.A. further demonstrates its commitment to the environment obtaining the **ISO 14001:2015** certificate to the productive site in Vestone.



Sustainability

Efficient processes and reliable products are no longer the only parameters used to perform an assessment of the quality of a company's conduct: the capacity of the company and its management to design and implement production process that are sustainable from an environmental point of view is of equal importance.

Valsir has started a project of Corporate Social Responsibility and has published its 1st Sustainability Report that gathers facts and figures relating to the daily commitment of Valsir in terms of social, economic and environmental responsibility.

For more information, download here the 1st Sustainability Report.

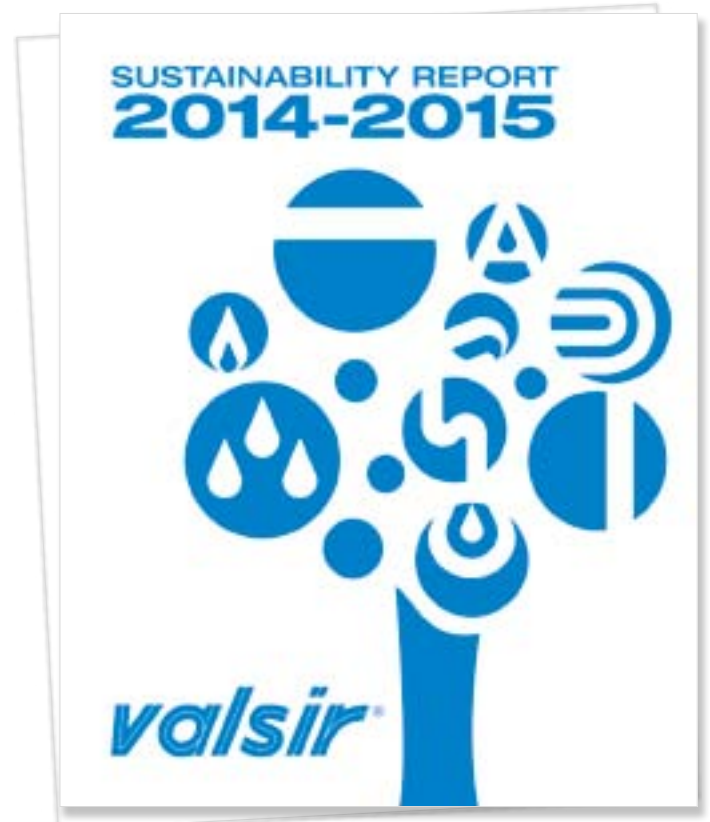

Download
valsir.it/u/sostenibilita-en

PLUMBING

WASTE SYSTEMS



SUPPLY SYSTEMS



GAS SYSTEMS



FLUSHING SYSTEMS



BATHROOM SYSTEMS



TRAPS



RADIANT SYSTEMS



DRAINAGE SYSTEMS



HRV SYSTEM



ACADEMY



SEWER SYSTEMS



WATER TREATMENT



BUILDING



VALSIR S.p.A.
Località Merlaro, 2
25078 Vestone (BS) - Italy
Tel. +39 0365 877.011
Fax +39 0365 81.268
e-mail: valsir@valsir.it

www.valsir.it

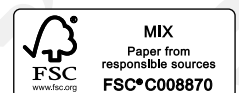

Soggetta all'attività di direzione e coordinamento ex art. 2497 bis C.C. da parte di Silmar Group S.p.A. - Codice Fiscale 02075160172

L02-730/1 - Maggio 2018

